

Peke

Bow spring - for gennaker sailing and easier bording, for all yachts

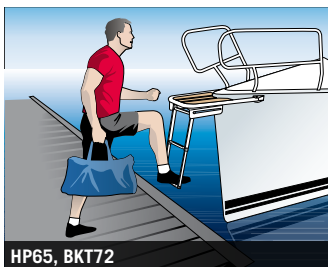

HP65, BKT72



Fenix - HP65



SeaRay 240 - MP75, BKT72



Bavaria BMB - MPA75

Ett peke kan göra underverk för din båt. Enklare ankring, bättre gennakersegling och mycket lättare att komma av och på båten. Tack vare vårt unika specialutformade fästsystem passar peket alltid. Du behöver bara välja efter båttyp (viss finjustering av trä och stag kan behövas). Våra peken är tillverkade i maskinpolerat rostfritt stål AiSi 316 och solid teak - snygga att se på och tåliga att slita på.

A bow spring will make wonders for your boating experience. Easier anchoring functionality, better gennaker sailing and higher accessibility when boarding or disembarking the boat. Thanks to our unique special designed fastening brackets the bow spring will always fit perfectly. All you have to do is choose according to your boat model (some fine tuning of steel supports and wood may be needed). Our bow springs are made from machine polished stainless steel AiSi 316 and solid teakwood - nice looking and durable.



HP 65

Hopp i land peke.
För båtar med gennaker, 50-60 m²
Bow spring for boats with gennaker, 50-60 m²

Passande stegar / Fitting ladders:
BKT72-250, BU55P

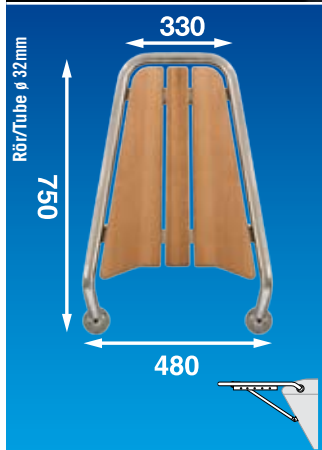

MP 75

Motorbåtspeke.
Bow spring for power boats.

Passande stegar / Fitting ladders:
BKT72, BKT73, BKT73T, BU57P, BU70P, BU75P
Passande pulpit / Fitting pulpit:
PP350



MPA 75

Motorbåtspeke med ankarhållare.
Bow spring for power boats + anchor roller.

Passande stegar / Fitting ladders:
BKT72, BKT73, BKT73T, BU57P, BU70P, BU75P
Passande pulpit / Fitting pulpit:
PP350

A Stag och/eller trämaterial skall finjusteras vid tillpassning på båten.
Supports and/or wooden material should be fine tuned when installed.

Stegar och Pulpit / Ladders and Pulpit



Rör ϕ 25 mm

BU 55P

Stega för peke inkl. fästbeslag.
Ladder for bow spring with fittings.



Rör ϕ 25 mm

BU 57P

Stega för peke inkl. fästbeslag.
Ladder for bow spring with fittings.

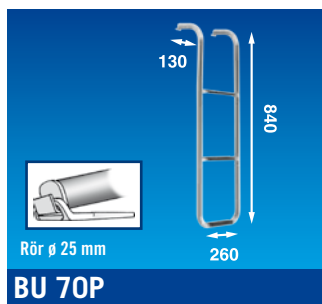

Rör ϕ 25 mm

BU 70P

Stega för peke inkl. fästbeslag.
Ladder for bow spring with fittings.



Rör ϕ 25 mm

BU 75P

Stävstege för peke med kraftiga handtag.
3 fotvänliga steg.
Ladder for bowspring with sturdy grips.
3 steps.

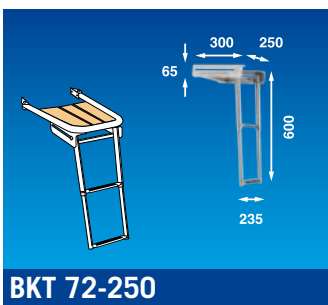

BKT 72-250

Teleskopstege i kassett 2 steg med låsning.
Telescopic ladder in casing, 2 steps with locking.

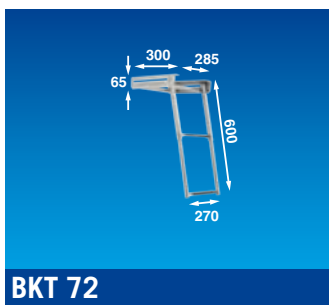

BKT 72

Teleskopstege i kassett 2 steg med låsning.
Telescopic ladder in casing, 2 steps with locking.



BKT 73, BKT73T (teak)

Teleskopstege i kassett 3 steg med låsning.
Telescopic ladder in casing, 3 steps with locking.

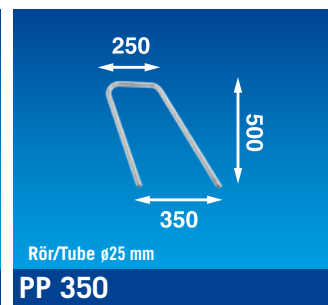

Rör/Tube ϕ 25 mm

PP 350

Pulpit till MP75 och MPA75.

För val av rätt plattform se sid 29. / Check out page 29 For choosing the right platform.

Peke -

▶ Rostfritt syrafast stål AiSi 316
Stainless steel AiSi 316



Bow spring - for gennaker sailing and easier bording, for all yachts



Beason 31 - GPT 100 + BKT 72



Elan 37 - GPAT100



Bavaria - PT10044



GPT 14042

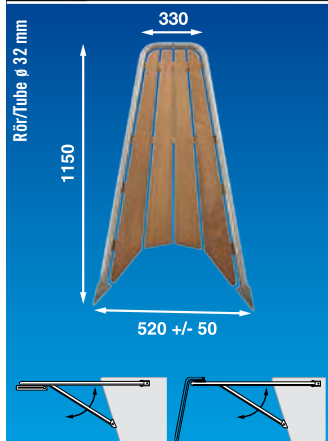

GPT 100

Peke för båtar 26'-35'.

Bow spring for boats 26'-35'.

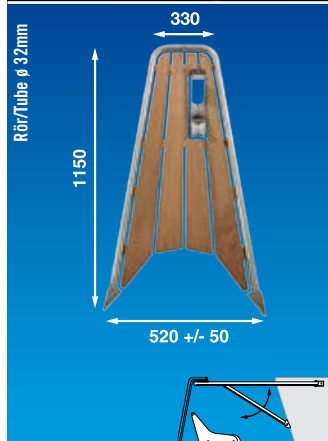

GPAT 100

Peke för båtar 26'-35'. Ankarrulle, max 15 kg.
Bow spring for boats 26'-35'. With anchor roller max 15 kg.

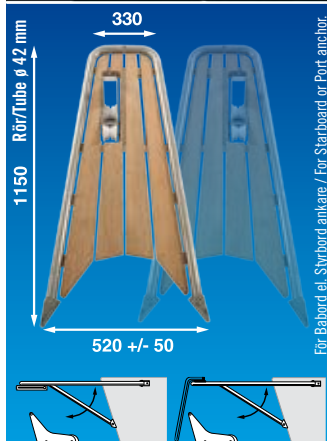

PT 10044

Peke för båtar 33'-45'. Ankarrulle, max 15 kg.
Vändbar teak för både styrbords- och babords-
montage av ankarrulle.

Bow spring for boats 33'-45'. With anchor roller max 15 kg. The teak can be switched for starboard or port mounting of the anchor roller.



GPT 14042

Peke för båtar 36'-45'. Ankarrulle, max 20 kg.
Bow spring for boats 36'-45'. With anchor roller max 20 kg.

Passande stegar / Fitting ladders:
BKT72, BKT73, BKT73T, BU57P, BU70P, BU75P

Passande stegar / Fitting ladders:
BU57P, BU70P, BU75P

Passande stegar / Fitting ladders:
BKT72, BKT73, BKT73T, BU57P, BU70P, BU75P
Passande pulpit / Fitting pulpit:
PPK600

Passande stegar / Fitting ladders:
BU70P-12
Passande pulpit / Fitting pulpit:
PPK800

A Stag och/eller trämaterial skall finjusteras vid tillpassning på båten. / Supports and/or wooden material should be fine tuned when installed.

Stegar och Pulpit / Ladders and Pulpit

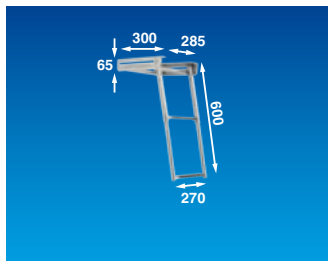

BKT 72

Teleskopstege i kassett 2 steg med låsning.
Telescopic ladder in casing, 2 steps with locking.

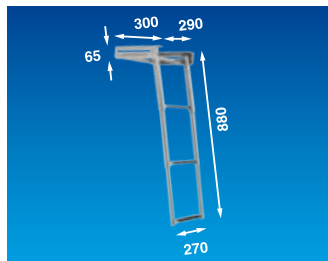

BKT 73

Teleskopstege i kassett 3 steg med låsning.
Telescopic ladder in casing, 3 steps with locking.

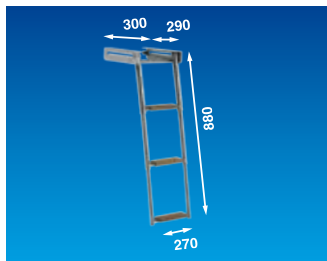

BKT 73T

Teleskopstege i kassett 3 teaksteg med låsning.
Telescopic ladder in casing, 3 teak steps, locking

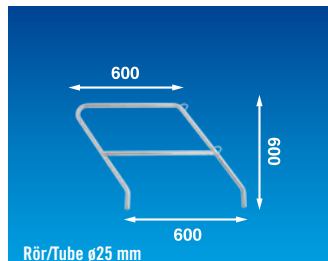

PPK 600

Pulpit till PT10044.
Pulpit for PT10044

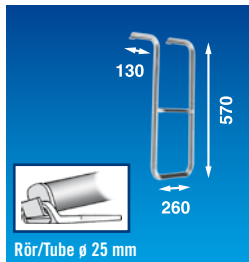

BU 57P

Stegar för peke inkl. fästbeslag.
Ladder for bow spring with fittings.

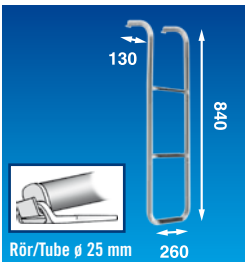

BU 70P

Stegar för peke inkl. fästbeslag.
Ladder for bow spring with fittings.

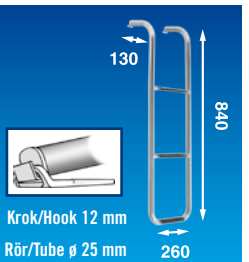

BU 70P-12

Stegar för peke GPT14042, inkl fästbeslag.
Ladder for bow spring GPT14042 with fittings.

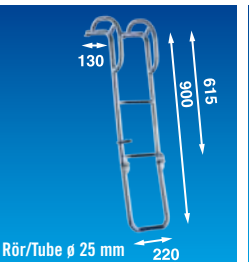

BU 75P

Stävsstegar för peke med kraftiga handtag. 3 fotvänliga steg.
Ladder for bowspring with sturdy grips. 3 steps.

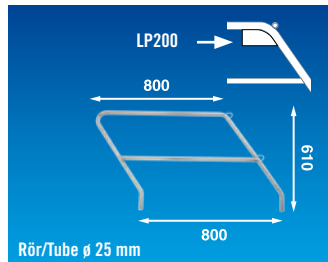

PPK 800 LP200

Pulpit till GPT14042. Lanternaplåt för PPK800
Pulpit for GPT14042 Light plate for PPK800

Galleri - peke

Gallery - bow spring



Dufour 34 Performance - HP65, BKT72-250



Bavaria BMB - MPA75

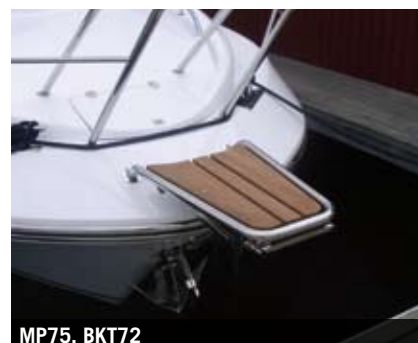

MP75, BKT72



CB365 - GPAT100, BUT75P



Omega 28 - HP65, BKT72-250



Dufour - PT 10044



Fenix - HP65



Hanse 312 - GPT100, BKT73



Dehler 34DD - HP65



Jeanneau Sun Fast 35 - PT10044



Albin Cumulus - HP65, BU55P



Nimo 27 - MP75, BKT72

Fler bilder hittar du på vår hemsida under galleri / More pictures at our homepage in gallery

Galleri - peke

Gallery - bow spring



Swedstar 370 - HP65



Elan - GPAT 100



Omega 36 - GPT 100 + BU 55P



Comfort 32 - GPT 100



Bavaria Vision 40 - PT10044, BKT72



Arcona 36- PT 10044



Jeanneau - PT10044



Bavaria 30 - GPAT100



Vinga Queen - GPT100 + BU70P



Maxi 999 - GPT100



Omega 34 - HP65



Bavaria 42 - PT10044, BKT72

Fler bilder hittar du på vår hemsida under galleri / More pictures at our homepage in gallery

www.batsystem.se

Vad passar på din båt?

What fits your boat?



Ta reda på vilken plattform som passar din båt / Find out which platform fits on your boat

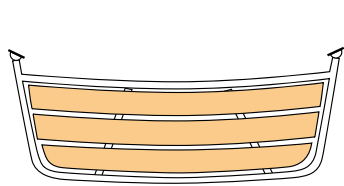

Teaken anpassas normalt inte (utom på speciella plattformar).
No adjustment for the teak is needed (except on special platforms).

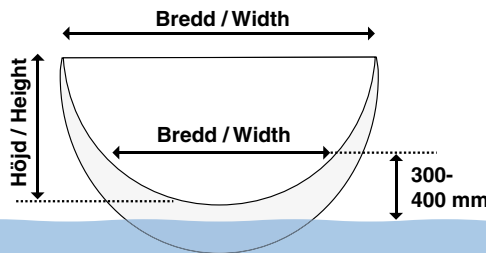

Mät på akterspeglen så ser du vilken plattform som får plats.
Measure the stern so you will know which platform fits.

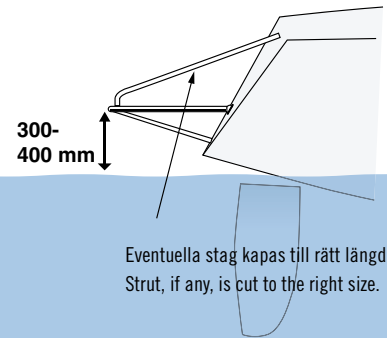

Eventuella stag kapas till rätt längd.
Strut, if any, is cut to the right size.

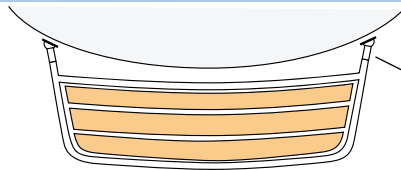

Vid starkt rundad akterspegel kan förlängning monteras.
If the stern is very round, extensions may be mounted.



P1009

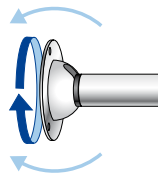

Justerbara universalbeslag för alla vinklar.
Adjustable universal fittings for all angles.

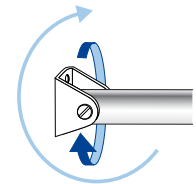

Justerbara u-beslag för alla vinklar.
Adjustable u-fittings for all angles.

Peke - passar alltid till din båt / Bow spring - always fits your boat

Välj först vad du vill ha för peke: Långt eller kort och med eller utan ankarhållare. Sedan monterar du bara enligt bifogad monteringsanvisning.

Decide first which bow spring you want: Long or short and with or without anchor holder. Then you mount the bow spring with the installation manual attached.

GPT100,
GPAT100
PT10044

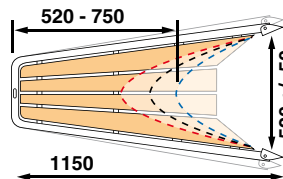

Anpassa teaken efter fören. / Adjust the teak for the bow.

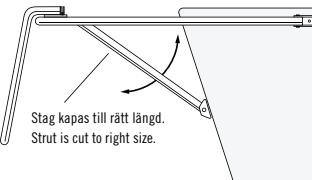
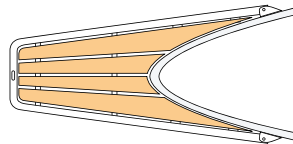

Stag kapas till rätt längd.
Strut is cut to right size.

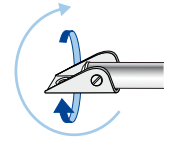

Justerbara u-beslag för alla vinklar.
Adjustable u-fittings for all angles.

GPT14042 -
samma princip /
same procedure

MP75, MPA75

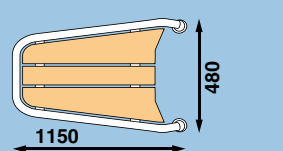

Teaken anpassas normalt inte. / No adjustment for the teak is needed.

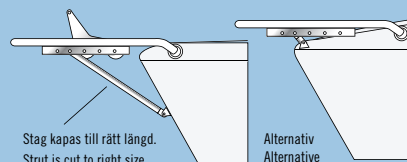
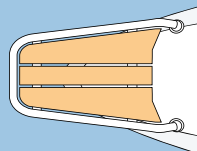

Stag kapas till rätt längd.
Strut is cut to right size.

Alternativ
Alternative

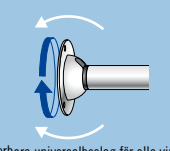

Justerbara universalbeslag för alla vinklar.
Adjustable universal fittings for all angles.

Vid befintlig ankarhållare kan förlängning monteras.
If an anchor holder already exists, extensions may be mounted.

P1010

HP 65

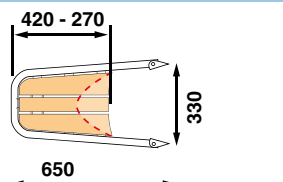

Anpassa teaken efter fören. / Adjust the teak for the bow.

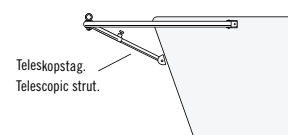
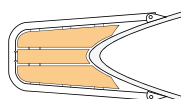

Teleskopstag.
Telescopic strut.

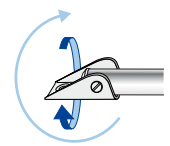

Justerbara u-beslag för alla vinklar.
Adjustable u-fittings for all angles.

A På vissa modeller av peken och badplattformar är stag och trämaterial i "råformat" vid leverans och skall finjusteras vid tillpassning på båten. Se ytterligare information i monteringsanvisningen.

Some models of bow springs come with supports and wooden material in "raw format" and should be fine tuned at installation. Further information is given in the mounting instructions supplied.

Rekommendationstabeller - segelbåt

Recommendation tables - sailing yachts



Båtsystem produkt	Kommentar	Arcona		Beneteau					CB	Delphia		Dufour				Elan + Impression				Hanse		Jeanneau			Promavia	Salona																									
		370	400	C39	F27.7	F34.7	O323	O343	O383	365	29	37	40	325	365	385	34P	40	44	31	333	34	37	40	344	384	434	315	342	370	S035	S039i	S045	S049	P32	L805	38	37	40	45											
Peke till segelbåt för ankring, gennaker och enklare ombordstigning:																																																			
HP 65	Utan ankarhållare				X													X																																	
GPT 100	Utan ankarhållare (ankarhållare kan eftermonteras)			X	X	X	X	X	X			X				X		X	X	X										X	X											X									
GPAT 100	Ankare upp till 15 kg			X	X	X	X	X				X						X	X	X																															
PT 10044	Ankare upp till 15 kg	X	X	X		X	X	X	X		X	X	X				X	X					X	X						X	X										X	X	X								
GPT 14042	Ankare upp till 20 kg	X	X					X								X	X																															X			
Peke till motorbåt för ankring och enklare ombordstigning:																																																			
MPA 75	Använder befintlig ankarhållare																																													X	X				
Stävstege till ovanstående peken:																																																			
BKT 72-250	2 steg. Passar enbart HP65				X														X																																
BKT 72	2 steg. Passar GPT 100, PT10044	X	X	X	X	X	X	X	X		X	X	X			X	X	X	X	X	X	X	X	X	X	X	X	X	X	X	X	X	X										X	X	X	X					
BKT 73 (T)*	3 steg. Passar GPT 100, PT10044	X	X	X	X	X	X	X	X		X	X	X			X	X	X	X	X	X	X	X	X	X	X	X	X	X	X	X	X										X	X	X	X						
BU 57P	2 steg. Passar alla peken (ej GPT14042)	X	X	X	X	X	X	X	X		X	X	X			X	X	X	X	X	X	X	X	X	X	X	X	X	X	X	X	X										X	X	X	X						
BU 70P	3 steg. Passar alla peken (ej GPT14042)	X	X	X	X	X	X	X	X		X	X	X			X	X	X	X	X	X	X	X	X	X	X	X	X	X	X	X	X										X	X	X	X						
BU 70P-12	3 steg. Passar GPT 14042		X	X				X								X	X																									X	X								
BU75P	3 steg. Passar alla peken (ej GPT14042)	X	X	X	X	X	X	X	X		X	X	X			X	X	X	X	X	X	X	X	X	X	X	X	X	X	X	X	X										X	X	X	X						
Stävstege att hänga i pulpit för segel- och motorbåtar:																																																			
ST 95	Stävstege									X																																									
ST 125	Stävstege							X	X	X									X	X								X	X																						
ST 130	Stävstege	X	X																		X	X	X	X	X	X	X	X	X																						
ST 140	Väska till ST 125 och ST 130	X	X					X	X	X									X	X	X	X	X	X	X	X	X	X	X																						
Ankarspel och dävertar:																																																			
1016-14XX	Inkl. monteringskit och säkring	X	X	X	X	X	X	X	X	X	X	X	X	X	X	X	X	X	X	X	X	X	X	X	X	X	X	X	X	X	X											X	X	X	X						
1100	Trådlös fjärrkontroll	X	X	X	X	X	X	X	X	X	X	X	X	X	X	X	X	X	X	X	X	X	X	X	X	X	X	X	X	X	X	X											X	X	X	X					
1410	Dävert för uppfällning	X	X	X	X	X	X	X	X	X	X	X	X	X	X	X	X	X	X	X	X	X	X	X	X	X	X	X	X	X	X												X	X	X	X					
1405	Dävert, justerbar	X	X	X	X	X	X	X	X	X	X	X	X	X	X	X	X	X	X	X	X	X	X	X	X	X	X	X	X	X	X												X	X	X	X					
1450	50 m blyad lina	X	X	X	X	X	X	X	X	X	X	X	X	X	X	X	X	X	X	X	X	X	X	X	X	X	X	X	X	X	X												X	X	X	X					
Radarmast, kompletta:																																																			
RA1-KIT	Montering på plant däck	X	X	X	X	X	X	X	X	X	X	X	X	X	X	X	X	X	X	X	X	X	X	X	X	X	X	X	X	X	X												X	X	X	X					
RA2-KIT	Montering, lutande / plant underlag	X	X	X	X	X	X	X	X	X	X	X	X	X	X	X	X	X	X	X	X	X	X	X	X	X	X	X	X	X	X	X												X	X	X	X				
RA3-KIT	Montering, lutande / plant underlag	X	X	X	X	X	X	X	X	X	X	X	X	X	X	X	X	X	X	X	X	X	X	X	X	X	X	X	X	X	X	X												X	X	X	X				

* Finns med teaksteg (BKT73T)



Kompleta monteringsanvisningar finns på vår hemsida. / You will find installation manuals on our homepage.

www.batsystem.se

Rekommendationstabeller - Bavaria

Recommendation tables - Bavaria



Båtsystem produkt	Kommentar	Bavaria motorbåt	Bavaria segelbåtar													Bavaria Match			Bavaria Vision		
		27'-42'	30'	31'	32'	33'	34'	36'	37'	38'	39'	42'	46'	50'	35'	38'	42'	40'	44'	50'	
Peke till segelbåt för ankring, gennaker och enklare ombordstigning:																					
GPT 100	Utan ankarhållare. (ankarhållare kan eftermonteras)		X	X	X	X	X								X						
GPAT 100	Ankare upp till 15 kg		X	X	X	X	X								X						
PT 10044	Ankare upp till 15 kg							X	X	X	X	X	X	X		X	X	X	X	X	
GPT 14042	Ankare upp till 20 kg								X	X	X	X	X	X				X	X	X	
Peke till motorbåt för ankring och enklare ombordstigning:																					
MP 75	Använder befintlig ankarhållare	X																			
Stävstege till ovanstående peken:																					
BKT 72	2 steg. Passar GPT 100, PT10044		X	X	X	X	X	X	X	X	X	X	X	X	X	X	X	X	X	X	
BKT 73 (T)*	3 steg. Passar GPT 100, PT10044		X	X	X	X	X	X	X	X	X	X	X	X	X	X	X	X	X	X	
BU 57P	2 steg. Passar alla peken (ej GPT14042).	X	X	X	X	X	X	X	X	X	X	X	X	X	X	X	X	X	X	X	
BU 70P	3 steg. Passar alla peken (ej GPT14042).	X	X	X	X	X	X	X	X	X	X	X	X	X	X	X	X	X	X	X	
BU 70P-12	3 steg. Passar GPT 14042.							X	X	X	X	X	X					X	X	X	
BU75P	3 steg. Passar alla peken (ej GPT14042).	X	X	X	X	X	X	X	X	X	X	X	X	X	X	X	X	X	X	X	
Stävstege att hänga i pulpit för Bavaria segel- och motorbåtar:																					
ST 125	Stävstege		X	X	X	X	X														
ST 130	Stävstege	X	X	X	X	X	X	X	X	X	X	X	X					X	X	X	
ST 140	Väska till ST 125 och ST 130.	X	X	X	X	X	X	X	X	X	X	X	X					X	X	X	
Ankarspel och dävertar:																					
1016-14XX	Inkl. monteringskit och säkring.	X	X	X	X	X	X	X	X	X	X	X						X			
1100	Trådlös fjärrkontroll	X	X	X	X	X	X	X	X	X	X							X			
1410	Dävert för uppfällning		X	X	X	X	X	X	X	X	X							X			
1405	Dävert, justerbar		X	X	X	X	X	X	X	X	X							X			
1415	Dävert för uppfällning, justerbar		X	X	X	X	X	X	X	X	X	X	X					X	X	X	
1450	50 m blyad lina	X	X	X	X	X	X	X	X	X	X							X			
1325	Ankarlift för Bruce	X																			
Radarmast, kompletta:																					
RA1-KIT	Montering på plant däck		X	X	X	X	X	X	X	X	X	X	X	X	X	X	X	X	X	X	
RA2-KIT	Montering, lutande / plant underlag		X	X	X	X	X	X	X	X	X	X	X	X	X	X	X	X	X	X	
RA3-KIT	Montering, lutande / plant underlag		X	X	X	X	X	X	X	X	X	X	X	X	X	X	X	X	X	X	

* Finns med teaksteg (BKT73T)



Kompletta monteringsanvisningar finns på vår hemsida. / You will find installation manuals on our homepage.